

ADO

880 SERIE PVC PROFILE SYSTEM

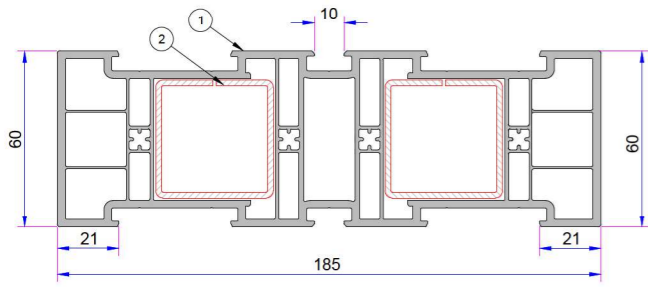

- Hebeschiebe Frame Profile**
P.A.930.1000.600.0.BC.01
- Reinforcement (40x40)**
2 mm - 34022 - 20110

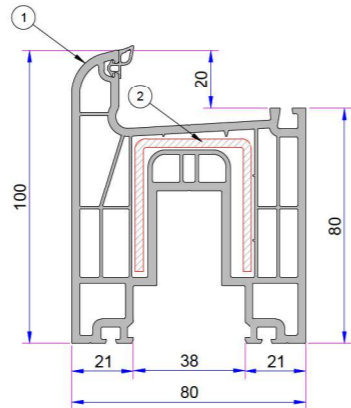

- Hebeschiebe Sash Profile**
P.A.930.2000.600.0.BC.01
- Reinforcement (45x40x45)**
2,5 mm - 34022 - 25001

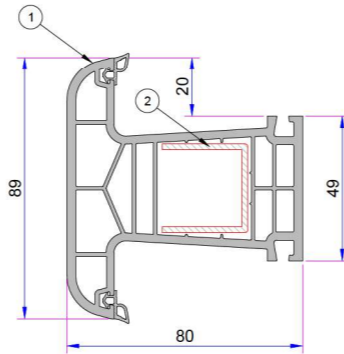

- Hebeschiebe Mullion Profile**
P.A.860.3000.600.0.BC.01
- Reinforcement (29x30x29)**
1,5 mm - 34022 - 15002
2,0 mm - 34022 - 20002

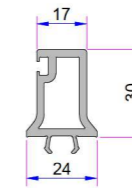
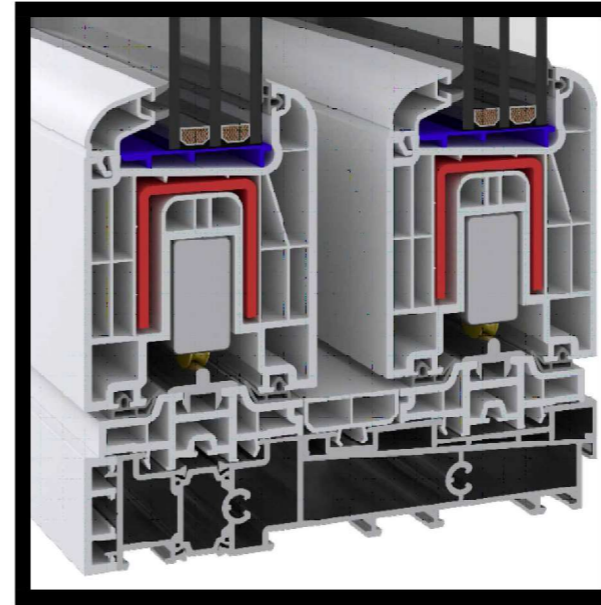

Hebeschiebe Frame Middle Adaptor
P.A.900.6503.600

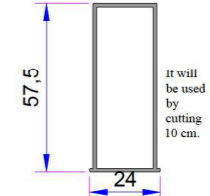

20mm'lik Alm. Sash Bedding
AD16-083

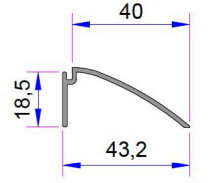

20mm Threshold Inner Profile
AD16-080

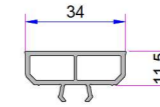

Hebeschiebe Sash Frame Middle Channel Cover
P.A.930.6505.600

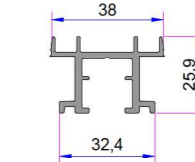

Frame Top Rail Aluminium
AD16-019

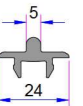

Sash Lower Rail Aluminium
AD16-020

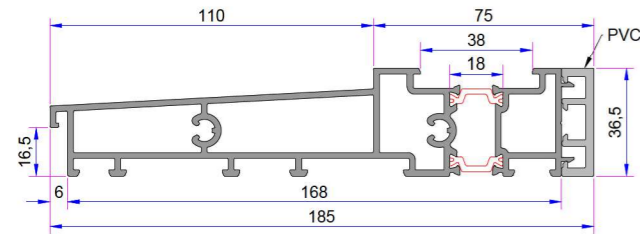

Hebeschiebe Interior Part PVC Thermo Insulation Aluminium Threshold
AD16-026

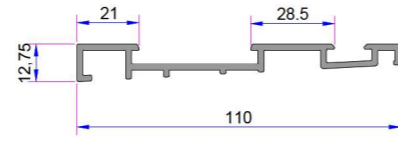

Aluminium Threshold Second Sash Rail
AD16-025

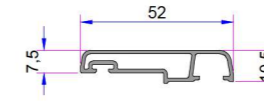

Frame Out Cornice Alm.
AD16-022

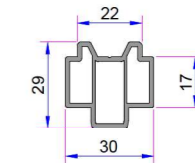

Stable Guide For Sash Aluminium
AD16-021

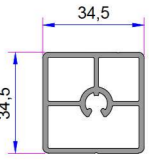

Frame Internal Puller Aluminium(8cm)
AD16-023

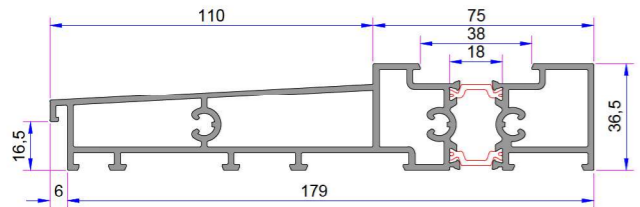

Hebeschiebe Aluminium Threshold with Thermo Insulation
AD16-027

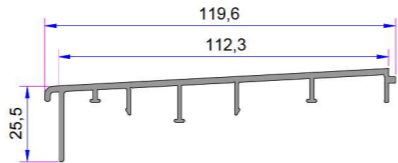

Hebeschiebe Aluminium Threshold Cover
AD16-024

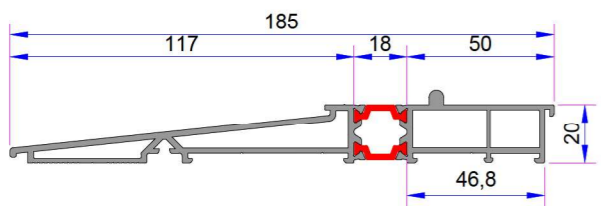

Hebeschiebe Aluminium Threshold with Thermo Insulation 20mm
AD16-079

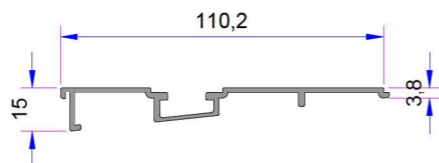

Aluminium Threshold Second Sash Rail
AD16-081

PVC Ve Alm. LowerFrame Corner Connection
21238.0000.0

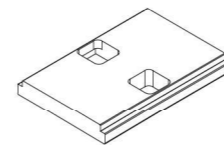

Double Sash Lower Middle Part Impermeability
21240.0001.L

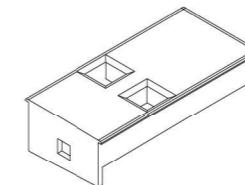

PVC Frame Connection Impermeability Seal

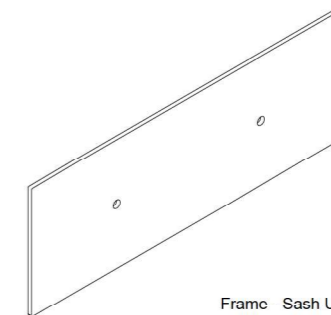

PVC ve Alm. Frame Connection Impermeability Seal

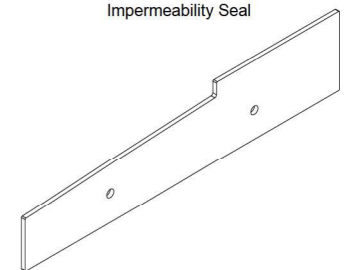

Multi Sash Below Part Impermeability
21240.0001.0

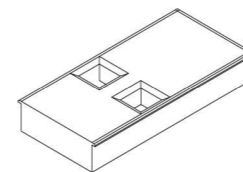

Double Sash Lower Middle Right Part Impermeability
21240.0000.R

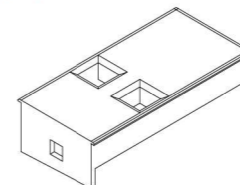

Frame Sash Upper Middle Impermeability
21239.0000.0

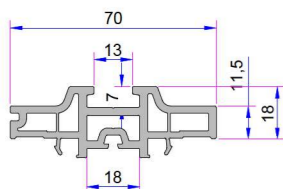
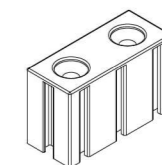

Hebeschiebe Sash and RailAdaptor
P.A.930.6500.600

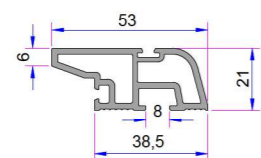

Hebeschiebe Sash Lap Strip Profile
P.A.930.6504.600

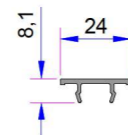

Second Threshold Rail Cover
AD16-082

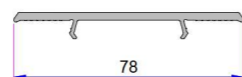

Hebeschiebe Sash Back & Frame Channel Cover
P.A.930.6506.600

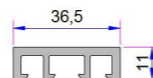

Aluminium Threshold Back Cover (PVC)
P.A.930.6502.600.0.0019

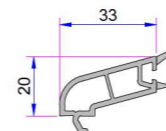

Double Glazing Bead (24mm)
P.A.800.4200.600.0.HC

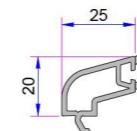

Triple Glazing Bead (32mm)
P.A.800.4500.600.0.HC

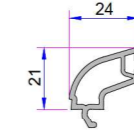

Triple Glazing Bead (32mm)
P.A.750.4204.600.0.HC

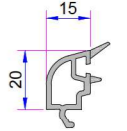

Triple Glazing Bead(42mm)
P.A.800.4600.600.0.HC